

M12 FEMALE 90° SHIELDED, B CODED ,INTERBUS

PUR 3x2x0.25 shielded violet 1.5m

Interbus
Female 90°
M12, 5-pole
B-coded
shielded

Further cable lengths on request.

Plastic housings with good resistance against chemicals and oils.

The resistance to aggressive media should be individually tested for your application. Further details on request.

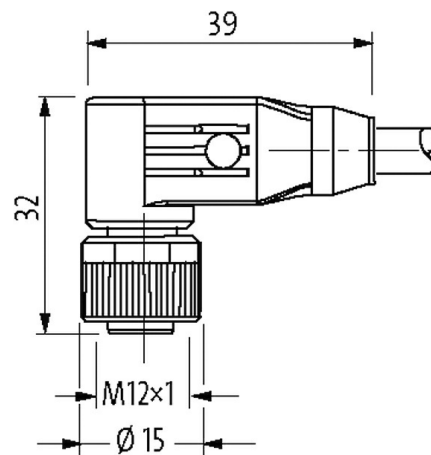
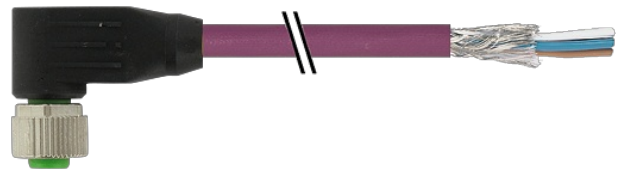
Illustration

Female

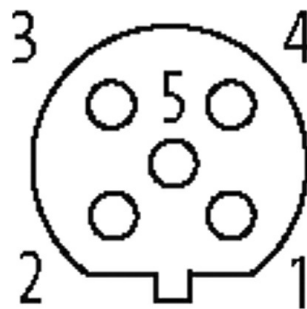

Product may differ from Image

Approvals



More Info



Form

Form 14271

Cables

No./diameter of wires	3 × (2 × AWG24)
Wire isolation	PE (whbr, grpk, gnye)
C-track properties	2 Mio.
Material (jacket)	PUR
Outer Ø	7.7 mm ±5%
Bend radius (moving)	15 × outer Ø
Temperature range (fixed)	-40...+70 °C
Temperature range (mobile)	-30...+70 °C
Cable identification	799
Approval (cable)	Interbus (DIN 19258/EN50254/IEC 61158 conform)
Cable weight [g/m]	76,49
Material (wire)	Cu wire, bare
Resistor (core)	max. 96 Ω/km (20 °C)
Single wire Ø (core)	0.1 mm
Construction (core)	32 × 0.1 mm (multi-strand wire class 6)
Diameter (core)	3 × (2 × AWG24)
AWG	similar to AWG 24
Material (wire isolation)	PE
Shore hardness (wire isolation)	55 ±5 D
Wire-Ø incl. isolation	1.4 mm ±5%
Color/numbering of wires	(wh, br) + (gr, pk) + (gn, ye)
Shield	yes
	min. 85%
Material (jacket)	PUR
Material property (jacket)	CFC-, halogen- and cadmium-free, matt, low-adhesion, machine easy to process, abrasion-resistant
Shore hardness (jacket)	85 ±5 A
Outer-Ø (jacket)	7.7 mm ±5%
Color (jacket)	violet
chemical resistance	good resistance to oil, gasoline and chemicals (VDE 0472 Teil 803/VDE 0249)
Nominal voltage	250 V AC
Test voltage	1500 V (wire/wire); 1000 V (wire/shield)
Temperature range (fixed)	-40...+80 °C
Temperature range (mobile)	-30...+70 °C
Bend radius (fixed)	6 × outer Ø
Bend radius (moving)	12 × outer Ø
No. of bending cycles (C-track)	max. 2 Mio. (25 °C)
Traversing distance (C-track)	max. 5 m (horizontal)
Travel speed (C-track)	max. 3 m/s

Acceleration (C-track)	max. 3 m/s ²
Jacket Color	violet

Technical Data

Operating voltage	max. 60 V AC/DC
Rated surge voltage	1.5 kV
Operating current per contact	max. 4 A
Material group	IEC 60664-1, category I
No. of poles	5
Coding	B-coded
Locking of ports	Screw thread (M12×1 mm) recommended torque 0.6 Nm, self-securing
Compression gland	M12 (SW13)
Protection	IP67 inserted and tightened (EN 60529)
Locking material	Zinc die casting, matte nickel plated

General data

Pollution Degree	3
Temperature range	-25...+85 °C, depending on cable quality

Commercial data

country of origin	DE
customs tariff number	85444290
EAN	4048879197557
eClass	27061801
Packaging unit	1

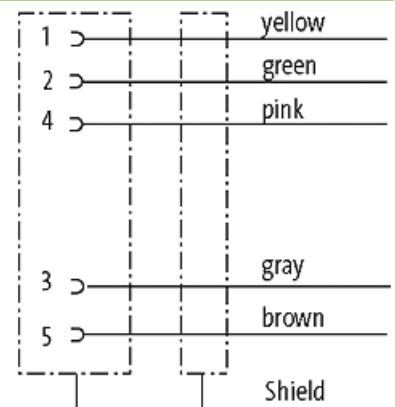
Sketch

Product may differ from Image